

FURNITURE II

collection

VOLUME 17

001

NAME

CGAxis Models Volume 17:
Furniture II Collection

FORMATS

- *.max (Scanline)
- *.max (MentalRay)
- *.max (VRay)
- *.c4d
- *.c4d (VRay)
- *.fbx
- *.obj

SPECIFICATION

Total size: 750MB
Materials: YES
Textures: YES

DESCRIPTION

CGAXIS models volume 17 containing 32 highly detailed models of furniture (sofas, armchairs, etc.) Great for your interiors, compatible with 3ds max 2008 or higher and many others.



All models, textures, renders, materials, hdri etc. which can be purchased/downloaded from www.cgaxis.com are on Royalty-Free non-exclusive license. License is personal and NON transferable. Models, textures, renders, materials, hdri etc. that You have purchased are non-exclusively licensed, NOT sold to You. You can use CGAxis products as a part of a game, if the products are contained inside a propriety format and displays inside the game during play. In this case, you have to add in the producer's section the information that "models by CGAXIS.com". You can sell/resell rendered moving or still images, resold as a part of a feature film, movie advertisement etc. You have a possibility to publish renders in a book, on a poster, t-shirt, magazine, cover or any other item. You have the right to use your renders in every way - charge a fee for them, modify them, to make postproduction etc.

FURNITURE II

collection

VOLUME 17

002

NAME

CGAxis Models Volume 17:
Furniture II Collection

FORMATS

- *.max (Scanline)
- *.max (MentalRay)
- *.max (VRay)
- *.c4d
- *.c4d (VRay)
- *.fbx
- *.obj

SPECIFICATION

Total size: 750MB
Materials: YES
Textures: YES

DESCRIPTION

CGAXIS models volume 17 containing 32 highly detailed models of furniture (sofas, armchairs, etc.) Great for your interiors, compatible with 3ds max 2008 or higher and many others.

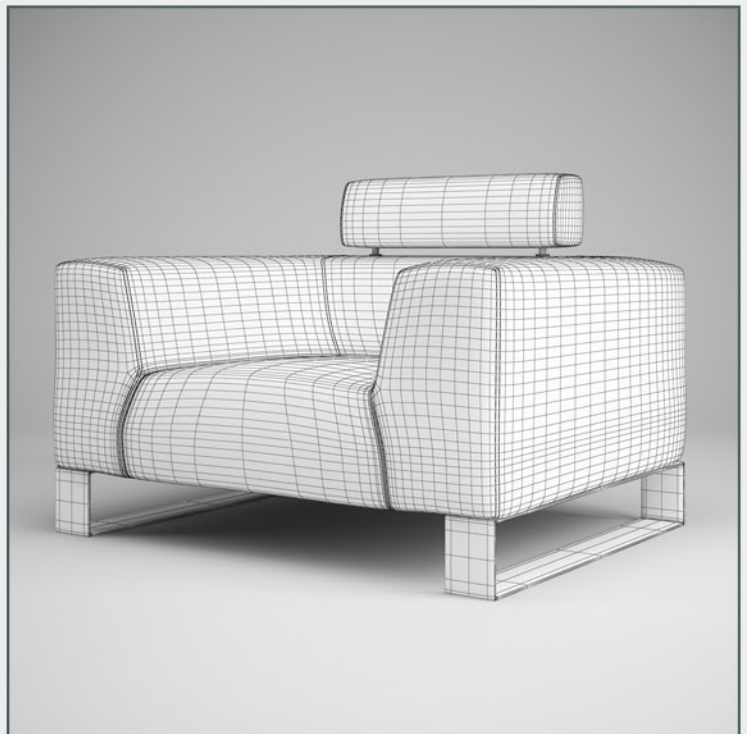

All models, textures, renders, materials, hdri etc. which can be purchased/downloaded from www.cgaxis.com are on Royalty-Free non-exclusive license. License is personal and NON transferable. Models, textures, renders, materials, hdri etc. that You have purchased are non-exclusively licensed, NOT sold to You. You can use CGAxis products as a part of a game, if the products are contained inside a propriety format and displays inside the game during play. In this case, you have to add in the producer's section the information that "models by CGAXIS.com". You can sell/resell rendered moving or still images, resold as a part of a feature film, movie advertisement etc. You have a possibility to publish renders in a book, on a poster, t-shirt, magazine, cover or any other item. You have the right to use your renders in every way - charge a fee for them, modify them, to make postproduction etc.

FURNITURE II

collection

VOLUME 17

003

NAME

CGAxis Models Volume 17:
Furniture II Collection

FORMATS

- *.max (Scanline)
- *.max (MentalRay)
- *.max (VRay)
- *.c4d
- *.c4d (VRay)
- *.fbx
- *.obj

SPECIFICATION

Total size: 750MB
Materials: YES
Textures: YES

DESCRIPTION

CGAXIS models volume 17 containing 32 highly detailed models of furniture (sofas, armchairs, etc.) Great for your interiors, compatible with 3ds max 2008 or higher and many others.

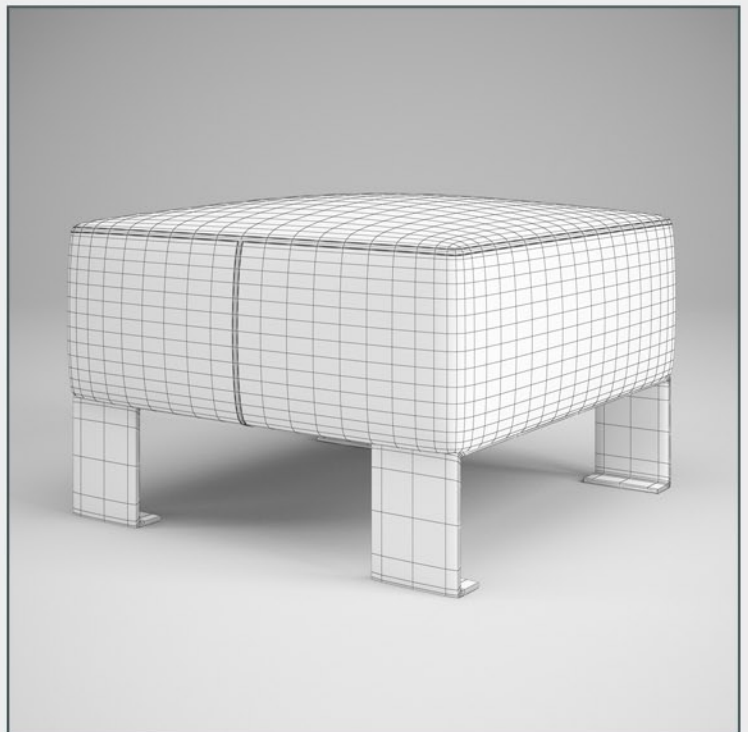

All models, textures, renders, materials, hdri etc. which can be purchased/downloaded from www.cgaxis.com are on Royalty-Free non-exclusive license. License is personal and NON transferable. Models, textures, renders, materials, hdri etc. that You have purchased are non-exclusively licensed, NOT sold to You. You can use CGAxis products as a part of a game, if the products are contained inside a propriety format and displays inside the game during play. In this case, you have to add in the producer's section the information that "models by CGAXIS.com". You can sell/resell rendered moving or still images, resold as a part of a feature film, movie advertisement etc. You have a possibility to publish renders in a book, on a poster, t-shirt, magazine, cover or any other item. You have the right to use your renders in every way - charge a fee for them, modify them, to make postproduction etc.

FURNITURE II

collection

VOLUME 17

004

NAME

CGAxis Models Volume 17:
Furniture II Collection

FORMATS

- *.max (Scanline)
- *.max (MentalRay)
- *.max (VRay)
- *.c4d
- *.c4d (VRay)
- *.fbx
- *.obj

SPECIFICATION

Total size: 750MB
Materials: YES
Textures: YES

DESCRIPTION

CGAXIS models volume 17 containing 32 highly detailed models of furniture (sofas, armchairs, etc.) Great for your interiors, compatible with 3ds max 2008 or higher and many others.



All models, textures, renders, materials, hdri etc. which can be purchased/downloaded from www.cgaxis.com are on Royalty-Free non-exclusive license. License is personal and NON transferable. Models, textures, renders, materials, hdri etc. that You have purchased are non-exclusively licensed, NOT sold to You. You can use CGAxis products as a part of a game, if the products are contained inside a propriety format and displays inside the game during play. In this case, you have to add in the producer's section the information that "models by CGAXIS.com". You can sell/resell rendered moving or still images, resold as a part of a feature film, movie advertisement etc. You have a possibility to publish renders in a book, on a poster, t-shirt, magazine, cover or any other item. You have the right to use your renders in every way - charge a fee for them, modify them, to make postproduction etc.

FURNITURE II

collection

VOLUME 17

005

NAME

CGAxis Models Volume 17:
Furniture II Collection

FORMATS

- *.max (Scanline)
- *.max (MentalRay)
- *.max (VRay)
- *.c4d
- *.c4d (VRay)
- *.fbx
- *.obj

SPECIFICATION

Total size: 750MB
Materials: YES
Textures: YES

DESCRIPTION

CGAXIS models volume 17 containing 32 highly detailed models of furniture (sofas, armchairs, etc.) Great for your interiors, compatible with 3ds max 2008 or higher and many others.

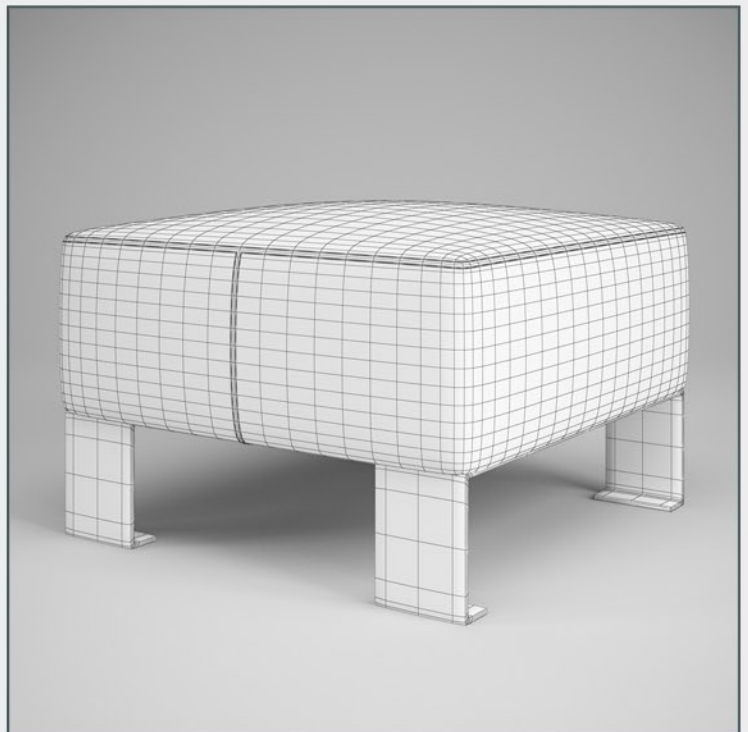

All models, textures, renders, materials, hdri etc. which can be purchased/downloaded from www.cgaxis.com are on Royalty-Free non-exclusive license. License is personal and NON transferable. Models, textures, renders, materials, hdri etc. that You have purchased are non-exclusively licensed, NOT sold to You. You can use CGAxis products as a part of a game, if the products are contained inside a propriety format and displays inside the game during play. In this case, you have to add in the producer's section the information that "models by CGAXIS.com". You can sell/resell rendered moving or still images, resold as a part of a feature film, movie advertisement etc. You have a possibility to publish renders in a book, on a poster, t-shirt, magazine, cover or any other item. You have the right to use your renders in every way - charge a fee for them, modify them, to make postproduction etc.

FURNITURE II

VOLUME 17

collection

006

NAME

CGAxis Models Volume 17:
Furniture II Collection

FORMATS

- *.max (Scanline)
- *.max (MentalRay)
- *.max (VRay)
- *.c4d
- *.c4d (VRay)
- *.fbx
- *.obj

SPECIFICATION

Total size: 750MB
Materials: YES
Textures: YES

DESCRIPTION

CGAXIS models volume 17 containing 32 highly detailed models of furniture (sofas, armchairs, etc.) Great for your interiors, compatible with 3ds max 2008 or higher and many others.



All models, textures, renders, materials, hdri etc. which can be purchased/downloaded from www.cgaxis.com are on Royalty-Free non-exclusive license. License is personal and NON transferable. Models, textures, renders, materials, hdri etc. that You have purchased are non-exclusively licensed, NOT sold to You. You can use CGAxis products as a part of a game, if the products are contained inside a propriety format and displays inside the game during play. In this case, you have to add in the producer's section the information that "models by CGAXIS.com". You can sell/resell rendered moving or still images, resold as a part of a feature film, movie advertisement etc. You have a possibility to publish renders in a book, on a poster, t-shirt, magazine, cover or any other item. You have the right to use your renders in every way - charge a fee for them, modify them, to make postproduction etc.

FURNITURE II

collection

VOLUME 17

007

NAME

CGAxis Models Volume 17:
Furniture II Collection

FORMATS

- *.max (Scanline)
- *.max (MentalRay)
- *.max (VRay)
- *.c4d
- *.c4d (VRay)
- *.fbx
- *.obj

SPECIFICATION

Total size: 750MB
Materials: YES
Textures: YES

DESCRIPTION

CGAXIS models volume 17 containing 32 highly detailed models of furniture (sofas, armchairs, etc.) Great for your interiors, compatible with 3ds max 2008 or higher and many others.



All models, textures, renders, materials, hdri etc. which can be purchased/downloaded from www.cgaxis.com are on Royalty-Free non-exclusive license. License is personal and NON transferable. Models, textures, renders, materials, hdri etc. that You have purchased are non-exclusively licensed, NOT sold to You. You can use CGAxis products as a part of a game, if the products are contained inside a propriety format and displays inside the game during play. In this case, you have to add in the producer's section the information that "models by CGAXIS.com". You can sell/resell rendered moving or still images, resold as a part of a feature film, movie advertisement etc. You have a possibility to publish renders in a book, on a poster, t-shirt, magazine, cover or any other item. You have the right to use your renders in every way - charge a fee for them, modify them, to make postproduction etc.

FURNITURE II

collection

VOLUME 17

008

NAME

CGAxis Models Volume 17:
Furniture II Collection

FORMATS

- *.max (Scanline)
- *.max (MentalRay)
- *.max (VRay)
- *.c4d
- *.c4d (VRay)
- *.fbx
- *.obj

SPECIFICATION

Total size: 750MB
Materials: YES
Textures: YES

DESCRIPTION

CGAXIS models volume 17 containing 32 highly detailed models of furniture (sofas, armchairs, etc.) Great for your interiors, compatible with 3ds max 2008 or higher and many others.

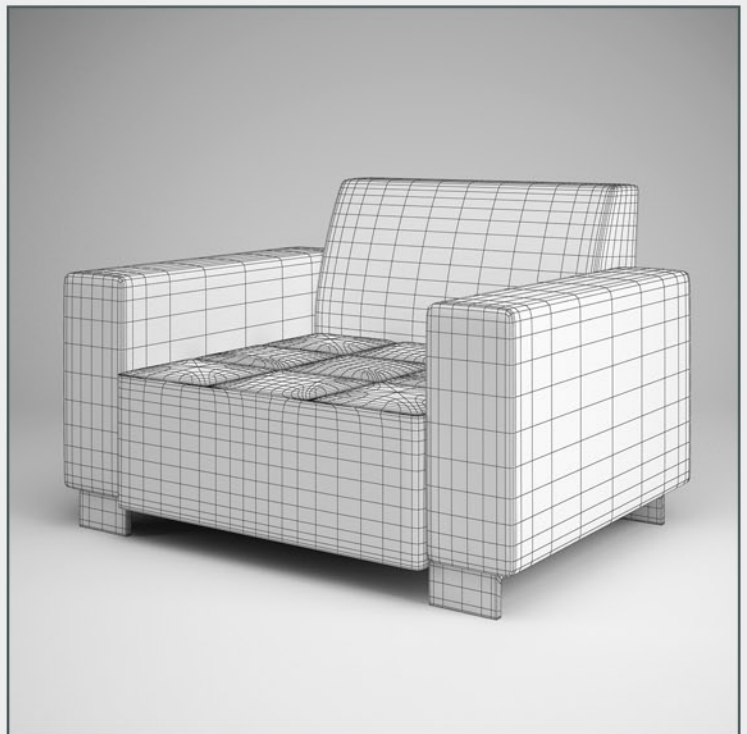

All models, textures, renders, materials, hdri etc. which can be purchased/downloaded from www.cgaxis.com are on Royalty-Free non-exclusive license. License is personal and NON transferable. Models, textures, renders, materials, hdri etc. that You have purchased are non-exclusively licensed, NOT sold to You. You can use CGAxis products as a part of a game, if the products are contained inside a propriety format and displays inside the game during play. In this case, you have to add in the producer's section the information that "models by CGAXIS.com". You can sell/resell rendered moving or still images, resold as a part of a feature film, movie advertisement etc. You have a possibility to publish renders in a book, on a poster, t-shirt, magazine, cover or any other item. You have the right to use your renders in every way - charge a fee for them, modify them, to make postproduction etc.

FURNITURE II

collection

VOLUME 17

009

NAME

CGAxis Models Volume 17:
Furniture II Collection

FORMATS

- *.max (Scanline)
- *.max (MentalRay)
- *.max (VRay)
- *.c4d
- *.c4d (VRay)
- *.fbx
- *.obj

SPECIFICATION

Total size: 750MB
Materials: YES
Textures: YES

DESCRIPTION

CGAXIS models volume 17 containing 32 highly detailed models of furniture (sofas, armchairs, etc.) Great for your interiors, compatible with 3ds max 2008 or higher and many others.

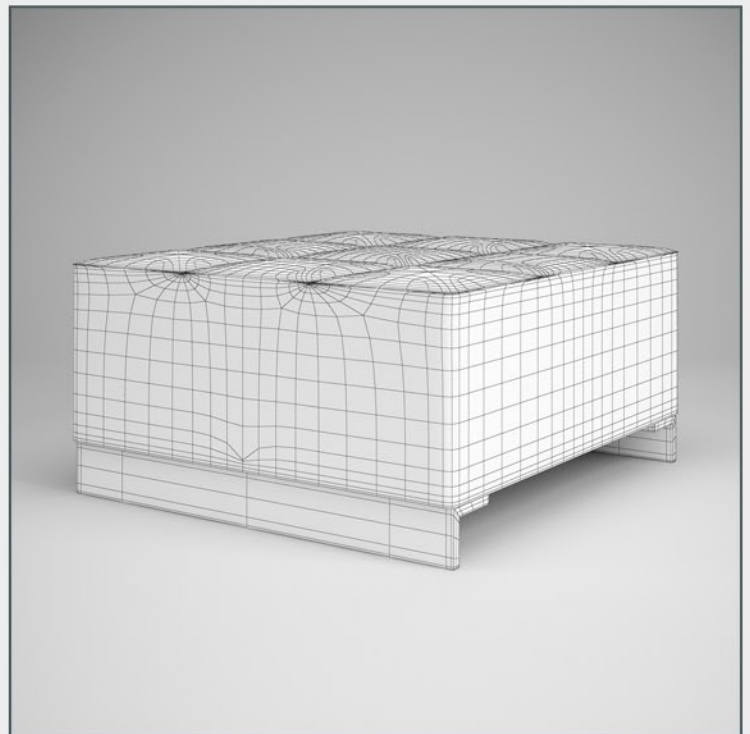

All models, textures, renders, materials, hdri etc. which can be purchased/downloaded from www.cgaxis.com are on Royalty-Free non-exclusive license. License is personal and NON transferable. Models, textures, renders, materials, hdri etc. that You have purchased are non-exclusively licensed, NOT sold to You. You can use CGAxis products as a part of a game, if the products are contained inside a propriety format and displays inside the game during play. In this case, you have to add in the producer's section the information that "models by CGAXIS.com". You can sell/resell rendered moving or still images, resold as a part of a feature film, movie advertisement etc. You have a possibility to publish renders in a book, on a poster, t-shirt, magazine, cover or any other item. You have the right to use your renders in every way - charge a fee for them, modify them, to make postproduction etc.

FURNITURE II

collection

VOLUME 17

010

NAME

CGAxis Models Volume 17:
Furniture II Collection

FORMATS

- *.max (Scanline)
- *.max (MentalRay)
- *.max (VRay)
- *.c4d
- *.c4d (VRay)
- *.fbx
- *.obj

SPECIFICATION

Total size: 750MB
Materials: YES
Textures: YES

DESCRIPTION

CGAXIS models volume 17 containing 32 highly detailed models of furniture (sofas, armchairs, etc.) Great for your interiors, compatible with 3ds max 2008 or higher and many others.

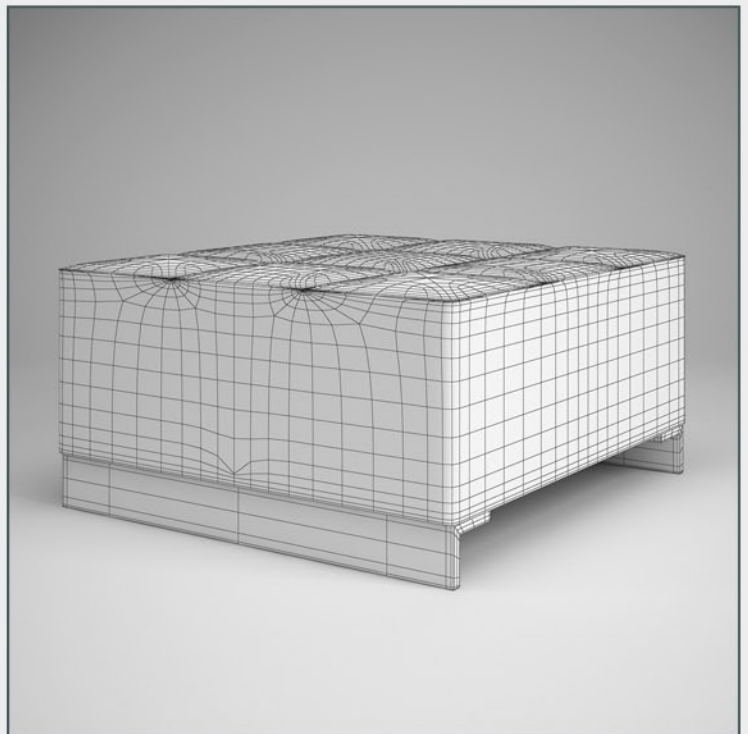
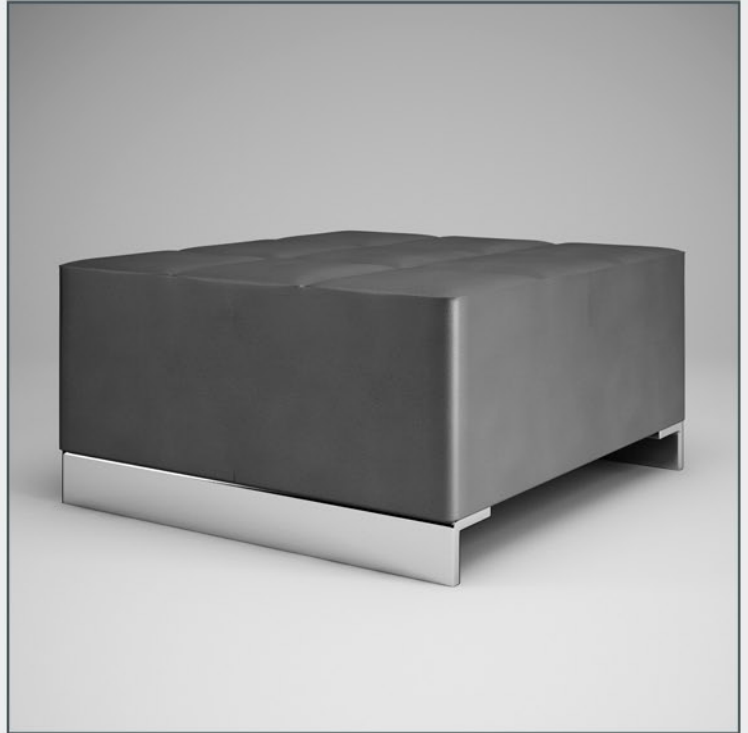

All models, textures, renders, materials, hdri etc. which can be purchased/downloaded from www.cgaxis.com are on Royalty-Free non-exclusive license. License is personal and NON transferable. Models, textures, renders, materials, hdri etc. that You have purchased are non-exclusively licensed, NOT sold to You. You can use CGAxis products as a part of a game, if the products are contained inside a propriety format and displays inside the game during play. In this case, you have to add in the producer's section the information that "models by CGAXIS.com". You can sell/resell rendered moving or still images, resold as a part of a feature film, movie advertisement etc. You have a possibility to publish renders in a book, on a poster, t-shirt, magazine, cover or any other item. You have the right to use your renders in every way - charge a fee for them, modify them, to make postproduction etc.

FURNITURE II

collection

VOLUME 17

011

NAME

CGAxis Models Volume 17:
Furniture II Collection

FORMATS

- *.max (Scanline)
- *.max (MentalRay)
- *.max (VRay)
- *.c4d
- *.c4d (VRay)
- *.fbx
- *.obj

SPECIFICATION

Total size: 750MB
Materials: YES
Textures: YES

DESCRIPTION

CGAXIS models volume 17 containing 32 highly detailed models of furniture (sofas, armchairs, etc.) Great for your interiors, compatible with 3ds max 2008 or higher and many others.

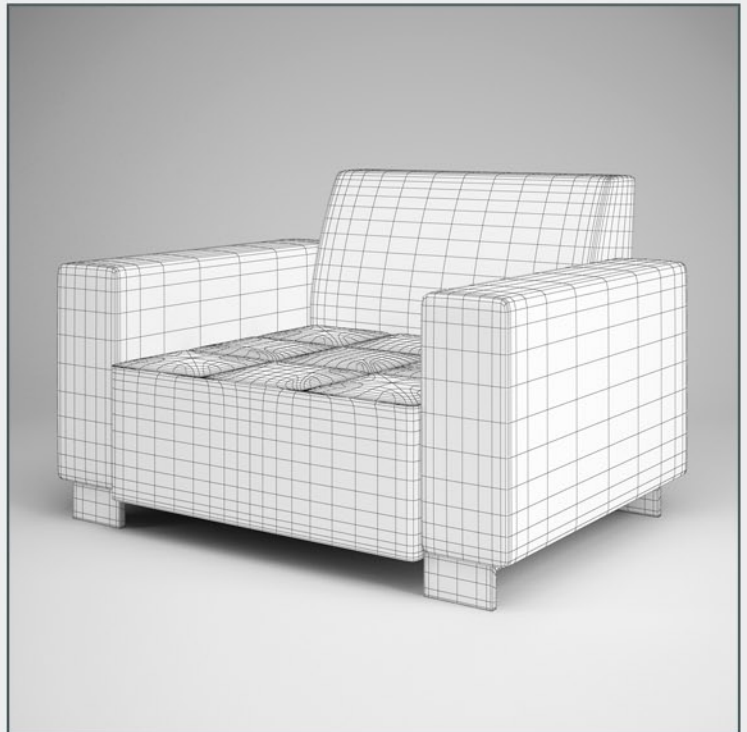

All models, textures, renders, materials, hdri etc. which can be purchased/downloaded from www.cgaxis.com are on Royalty-Free non-exclusive license. License is personal and NON transferable. Models, textures, renders, materials, hdri etc. that You have purchased are non-exclusively licensed, NOT sold to You. You can use CGAxis products as a part of a game, if the products are contained inside a propriety format and displays inside the game during play. In this case, you have to add in the producer's section the information that "models by CGAXIS.com". You can sell/resell rendered moving or still images, resold as a part of a feature film, movie advertisement etc. You have a possibility to publish renders in a book, on a poster, t-shirt, magazine, cover or any other item. You have the right to use your renders in every way - charge a fee for them, modify them, to make postproduction etc.

FURNITURE II

collection

VOLUME 17

012

NAME

CGAxis Models Volume 17:
Furniture II Collection

FORMATS

- *.max (Scanline)
- *.max (MentalRay)
- *.max (VRay)
- *.c4d
- *.c4d (VRay)
- *.fbx
- *.obj

SPECIFICATION

Total size: 750MB
Materials: YES
Textures: YES

DESCRIPTION

CGAXIS models volume 17 containing 32 highly detailed models of furniture (sofas, armchairs, etc.) Great for your interiors, compatible with 3ds max 2008 or higher and many others.



All models, textures, renders, materials, hdri etc. which can be purchased/downloaded from www.cgaxis.com are on Royalty-Free non-exclusive license. License is personal and NON transferable. Models, textures, renders, materials, hdri etc. that You have purchased are non-exclusively licensed, NOT sold to You. You can use CGAxis products as a part of a game, if the products are contained inside a propriety format and displays inside the game during play. In this case, you have to add in the producer's section the information that "models by CGAXIS.com". You can sell/resell rendered moving or still images, resold as a part of a feature film, movie advertisement etc. You have a possibility to publish renders in a book, on a poster, t-shirt, magazine, cover or any other item. You have the right to use your renders in every way - charge a fee for them, modify them, to make postproduction etc.

FURNITURE II

collection

VOLUME 17

013

NAME

CGAxis Models Volume 17:
Furniture II Collection

FORMATS

- *.max (Scanline)
- *.max (MentalRay)
- *.max (VRay)
- *.c4d
- *.c4d (VRay)
- *.fbx
- *.obj

SPECIFICATION

Total size: 750MB
Materials: YES
Textures: YES

DESCRIPTION

CGAXIS models volume 17 containing 32 highly detailed models of furniture (sofas, armchairs, etc.) Great for your interiors, compatible with 3ds max 2008 or higher and many others.



All models, textures, renders, materials, hdri etc. which can be purchased/downloaded from www.cgaxis.com are on Royalty-Free non-exclusive license. License is personal and NON transferable. Models, textures, renders, materials, hdri etc. that You have purchased are non-exclusively licensed, NOT sold to You. You can use CGAxis products as a part of a game, if the products are contained inside a propriety format and displays inside the game during play. In this case, you have to add in the producer's section the information that "models by CGAXIS.com". You can sell/resell rendered moving or still images, resold as a part of a feature film, movie advertisement etc. You have a possibility to publish renders in a book, on a poster, t-shirt, magazine, cover or any other item. You have the right to use your renders in every way - charge a fee for them, modify them, to make postproduction etc.

FURNITURE II

collection

VOLUME 17

014

NAME

CGAxis Models Volume 17:
Furniture II Collection

FORMATS

- *.max (Scanline)
- *.max (MentalRay)
- *.max (VRay)
- *.c4d
- *.c4d (VRay)
- *.fbx
- *.obj

SPECIFICATION

Total size: 750MB
Materials: YES
Textures: YES

DESCRIPTION

CGAXIS models volume 17 containing 32 highly detailed models of furniture (sofas, armchairs, etc.) Great for your interiors, compatible with 3ds max 2008 or higher and many others.



All models, textures, renders, materials, hdri etc. which can be purchased/downloaded from www.cgaxis.com are on Royalty-Free non-exclusive license. License is personal and NON transferable. Models, textures, renders, materials, hdri etc. that You have purchased are non-exclusively licensed, NOT sold to You. You can use CGAxis products as a part of a game, if the products are contained inside a propriety format and displays inside the game during play. In this case, you have to add in the producer's section the information that "models by CGAXIS.com". You can sell/resell rendered moving or still images, resold as a part of a feature film, movie advertisement etc. You have a possibility to publish renders in a book, on a poster, t-shirt, magazine, cover or any other item. You have the right to use your renders in every way - charge a fee for them, modify them, to make postproduction etc.

FURNITURE II

collection

VOLUME 17

015

NAME

CGAxis Models Volume 17:
Furniture II Collection

FORMATS

- *.max (Scanline)
- *.max (MentalRay)
- *.max (VRay)
- *.c4d
- *.c4d (VRay)
- *.fbx
- *.obj

SPECIFICATION

Total size: 750MB
Materials: YES
Textures: YES

DESCRIPTION

CGAXIS models volume 17 containing 32 highly detailed models of furniture (sofas, armchairs, etc.) Great for your interiors, compatible with 3ds max 2008 or higher and many others.

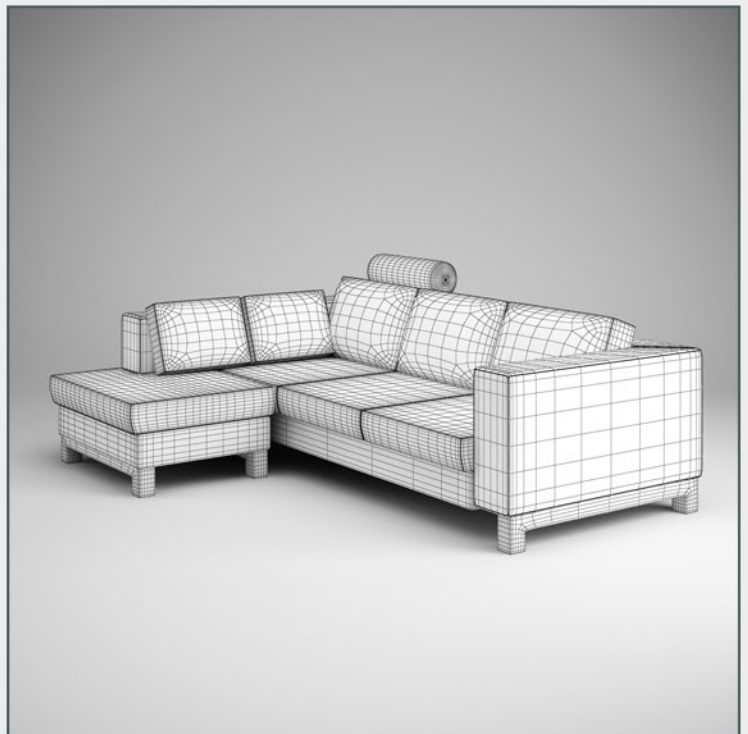

All models, textures, renders, materials, hdri etc. which can be purchased/downloaded from www.cgaxis.com are on Royalty-Free non-exclusive license. License is personal and NON transferable. Models, textures, renders, materials, hdri etc. that You have purchased are non-exclusively licensed, NOT sold to You. You can use CGAxis products as a part of a game, if the products are contained inside a propriety format and displays inside the game during play. In this case, you have to add in the producer's section the information that "models by CGAXIS.com". You can sell/resell rendered moving or still images, resold as a part of a feature film, movie advertisement etc. You have a possibility to publish renders in a book, on a poster, t-shirt, magazine, cover or any other item. You have the right to use your renders in every way - charge a fee for them, modify them, to make postproduction etc.

FURNITURE II

collection

VOLUME 17

016

NAME

CGAxis Models Volume 17:
Furniture II Collection

FORMATS

- *.max (Scanline)
- *.max (MentalRay)
- *.max (VRay)
- *.c4d
- *.c4d (VRay)
- *.fbx
- *.obj

SPECIFICATION

Total size: 750MB
Materials: YES
Textures: YES

DESCRIPTION

CGAXIS models volume 17 containing 32 highly detailed models of furniture (sofas, armchairs, etc.) Great for your interiors, compatible with 3ds max 2008 or higher and many others.

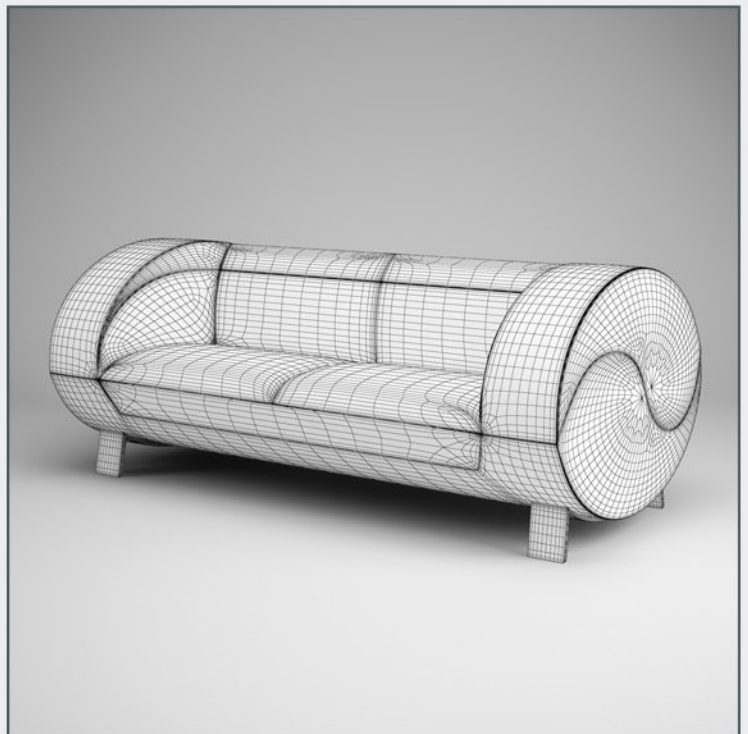

All models, textures, renders, materials, hdri etc. which can be purchased/downloaded from www.cgaxis.com are on Royalty-Free non-exclusive license. License is personal and NON transferable. Models, textures, renders, materials, hdri etc. that You have purchased are non-exclusively licensed, NOT sold to You. You can use CGAxis products as a part of a game, if the products are contained inside a propriety format and displays inside the game during play. In this case, you have to add in the producer's section the information that "models by CGAXIS.com". You can sell/resell rendered moving or still images, resold as a part of a feature film, movie advertisement etc. You have a possibility to publish renders in a book, on a poster, t-shirt, magazine, cover or any other item. You have the right to use your renders in every way - charge a fee for them, modify them, to make postproduction etc.

FURNITURE II

collection

VOLUME 17

017

NAME

CGAxis Models Volume 17:
Furniture II Collection

FORMATS

- *.max (Scanline)
- *.max (MentalRay)
- *.max (VRay)
- *.c4d
- *.c4d (VRay)
- *.fbx
- *.obj

SPECIFICATION

Total size: 750MB
Materials: YES
Textures: YES

DESCRIPTION

CGAXIS models volume 17 containing 32 highly detailed models of furniture (sofas, armchairs, etc.) Great for your interiors, compatible with 3ds max 2008 or higher and many others.

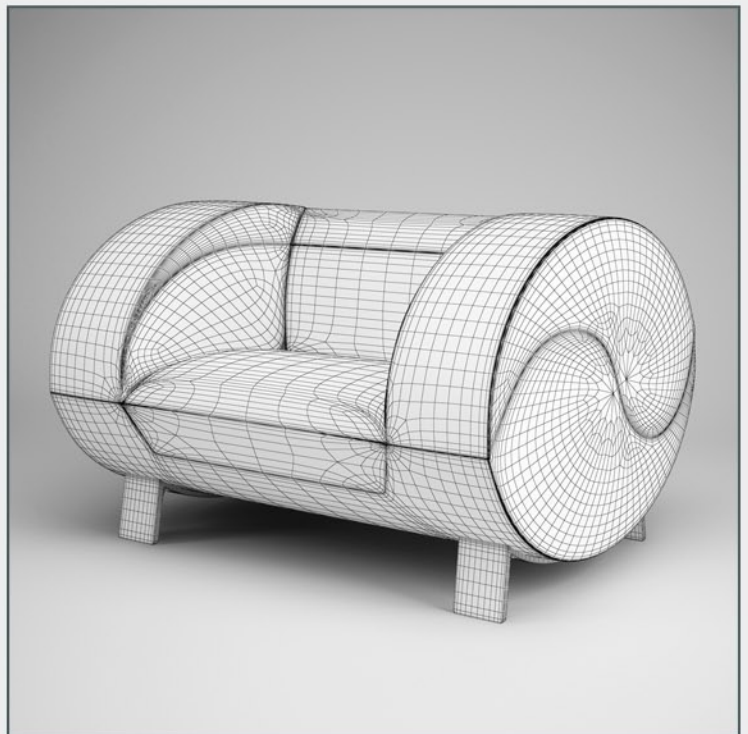

All models, textures, renders, materials, hdri etc. which can be purchased/downloaded from www.cgaxis.com are on Royalty-Free non-exclusive license. License is personal and NON transferable. Models, textures, renders, materials, hdri etc. that You have purchased are non-exclusively licensed, NOT sold to You. You can use CGAxis products as a part of a game, if the products are contained inside a propriety format and displays inside the game during play. In this case, you have to add in the producer's section the information that "models by CGAXIS.com". You can sell/resell rendered moving or still images, resold as a part of a feature film, movie advertisement etc. You have a possibility to publish renders in a book, on a poster, t-shirt, magazine, cover or any other item. You have the right to use your renders in every way - charge a fee for them, modify them, to make postproduction etc.

FURNITURE II

collection

VOLUME 17

018

NAME

CGAxis Models Volume 17:
Furniture II Collection

FORMATS

- *.max (Scanline)
- *.max (MentalRay)
- *.max (VRay)
- *.c4d
- *.c4d (VRay)
- *.fbx
- *.obj

SPECIFICATION

Total size: 750MB
Materials: YES
Textures: YES

DESCRIPTION

CGAXIS models volume 17 containing 32 highly detailed models of furniture (sofas, armchairs, etc.) Great for your interiors, compatible with 3ds max 2008 or higher and many others.



All models, textures, renders, materials, hdri etc. which can be purchased/downloaded from www.cgaxis.com are on Royalty-Free non-exclusive license. License is personal and NON transferable. Models, textures, renders, materials, hdri etc. that You have purchased are non-exclusively licensed, NOT sold to You. You can use CGAxis products as a part of a game, if the products are contained inside a propriety format and displays inside the game during play. In this case, you have to add in the producer's section the information that "models by CGAXIS.com". You can sell/resell rendered moving or still images, resold as a part of a feature film, movie advertisement etc. You have a possibility to publish renders in a book, on a poster, t-shirt, magazine, cover or any other item. You have the right to use your renders in every way - charge a fee for them, modify them, to make postproduction etc.

FURNITURE II

collection

VOLUME 17

019

NAME

CGAxis Models Volume 17:
Furniture II Collection

FORMATS

- *.max (Scanline)
- *.max (MentalRay)
- *.max (VRay)
- *.c4d
- *.c4d (VRay)
- *.fbx
- *.obj

SPECIFICATION

Total size: 750MB
Materials: YES
Textures: YES

DESCRIPTION

CGAXIS models volume 17 containing 32 highly detailed models of furniture (sofas, armchairs, etc.) Great for your interiors, compatible with 3ds max 2008 or higher and many others.



All models, textures, renders, materials, hdri etc. which can be purchased/downloaded from www.cgaxis.com are on Royalty-Free non-exclusive license. License is personal and NON transferable. Models, textures, renders, materials, hdri etc. that You have purchased are non-exclusively licensed, NOT sold to You. You can use CGAxis products as a part of a game, if the products are contained inside a propriety format and displays inside the game during play. In this case, you have to add in the producer's section the information that "models by CGAXIS.com". You can sell/resell rendered moving or still images, resold as a part of a feature film, movie advertisement etc. You have a possibility to publish renders in a book, on a poster, t-shirt, magazine, cover or any other item. You have the right to use your renders in every way - charge a fee for them, modify them, to make postproduction etc.

FURNITURE II

collection

VOLUME 17



NAME

CGAxis Models Volume 17:
Furniture II Collection

FORMATS

- *.max (Scanline)
- *.max (MentalRay)
- *.max (VRay)
- *.c4d
- *.c4d (VRay)
- *.fbx
- *.obj

SPECIFICATION

Total size: 750MB
Materials: YES
Textures: YES

DESCRIPTION

CGAXIS models volume 17 containing 32 highly detailed models of furniture (sofas, armchairs, etc.) Great for your interiors, compatible with 3ds max 2008 or higher and many others.

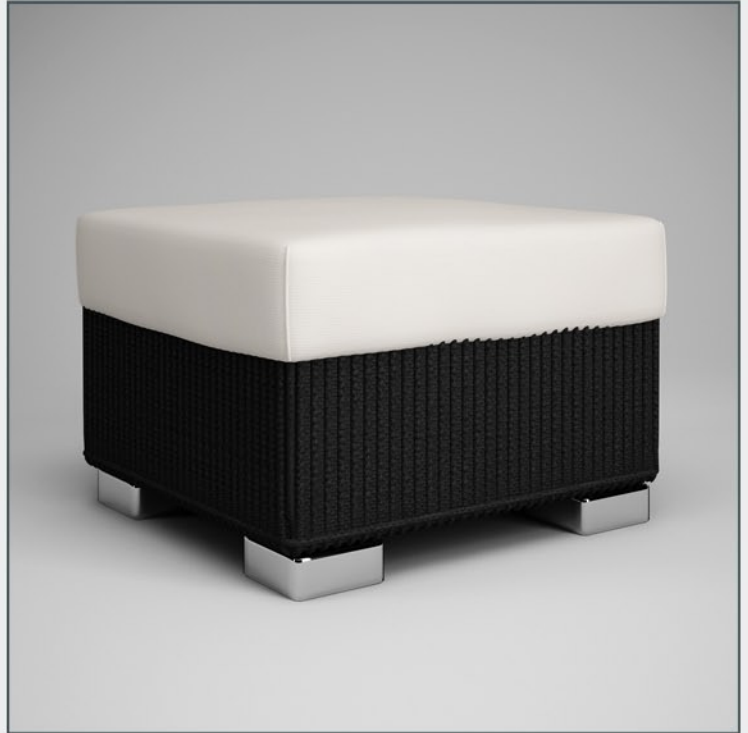

All models, textures, renders, materials, hdri etc. which can be purchased/downloaded from www.cgaxis.com are on Royalty-Free non-exclusive license. License is personal and NON transferable. Models, textures, renders, materials, hdri etc. that You have purchased are non-exclusively licensed, NOT sold to You. You can use CGAxis products as a part of a game, if the products are contained inside a propriety format and displays inside the game during play. In this case, you have to add in the producer's section the information that "models by CGAXIS.com". You can sell/resell rendered moving or still images, resold as a part of a feature film, movie advertisement etc. You have a possibility to publish renders in a book, on a poster, t-shirt, magazine, cover or any other item. You have the right to use your renders in every way - charge a fee for them, modify them, to make postproduction etc.

FURNITURE II

collection

VOLUME 17

021

NAME

CGAxis Models Volume 17:
Furniture II Collection

FORMATS

- *.max (Scanline)
- *.max (MentalRay)
- *.max (VRay)
- *.c4d
- *.c4d (VRay)
- *.fbx
- *.obj

SPECIFICATION

Total size: 750MB
Materials: YES
Textures: YES

DESCRIPTION

CGAXIS models volume 17 containing 32 highly detailed models of furniture (sofas, armchairs, etc.) Great for your interiors, compatible with 3ds max 2008 or higher and many others.



All models, textures, renders, materials, hdri etc. which can be purchased/downloaded from www.cgaxis.com are on Royalty-Free non-exclusive license. License is personal and NON transferable. Models, textures, renders, materials, hdri etc. that You have purchased are non-exclusively licensed, NOT sold to You. You can use CGAxis products as a part of a game, if the products are contained inside a propriety format and displays inside the game during play. In this case, you have to add in the producer's section the information that "models by CGAXIS.com". You can sell/resell rendered moving or still images, resold as a part of a feature film, movie advertisement etc. You have a possibility to publish renders in a book, on a poster, t-shirt, magazine, cover or any other item. You have the right to use your renders in every way - charge a fee for them, modify them, to make postproduction etc.

FURNITURE II

collection

VOLUME 17

022

NAME

CGAxis Models Volume 17:
Furniture II Collection

FORMATS

- *.max (Scanline)
- *.max (MentalRay)
- *.max (VRay)
- *.c4d
- *.c4d (VRay)
- *.fbx
- *.obj

SPECIFICATION

Total size: 750MB
Materials: YES
Textures: YES

DESCRIPTION

CGAXIS models volume 17 containing 32 highly detailed models of furniture (sofas, armchairs, etc.) Great for your interiors, compatible with 3ds max 2008 or higher and many others.



All models, textures, renders, materials, hdri etc. which can be purchased/downloaded from www.cgaxis.com are on Royalty-Free non-exclusive license. License is personal and NON transferable. Models, textures, renders, materials, hdri etc. that You have purchased are non-exclusively licensed, NOT sold to You. You can use CGAxis products as a part of a game, if the products are contained inside a propriety format and displays inside the game during play. In this case, you have to add in the producer's section the information that "models by CGAXIS.com". You can sell/resell rendered moving or still images, resold as a part of a feature film, movie advertisement etc. You have a possibility to publish renders in a book, on a poster, t-shirt, magazine, cover or any other item. You have the right to use your renders in every way - charge a fee for them, modify them, to make postproduction etc.

FURNITURE II

collection

VOLUME 17

023

NAME

CGAxis Models Volume 17:
Furniture II Collection

FORMATS

- *.max (Scanline)
- *.max (MentalRay)
- *.max (VRay)
- *.c4d
- *.c4d (VRay)
- *.fbx
- *.obj

SPECIFICATION

Total size: 750MB
Materials: YES
Textures: YES

DESCRIPTION

CGAXIS models volume 17 containing 32 highly detailed models of furniture (sofas, armchairs, etc.) Great for your interiors, compatible with 3ds max 2008 or higher and many others.



All models, textures, renders, materials, hdri etc. which can be purchased/downloaded from www.cgaxis.com are on Royalty-Free non-exclusive license. License is personal and NON transferable. Models, textures, renders, materials, hdri etc. that You have purchased are non-exclusively licensed, NOT sold to You. You can use CGAxis products as a part of a game, if the products are contained inside a propriety format and displays inside the game during play. In this case, you have to add in the producer's section the information that "models by CGAXIS.com". You can sell/resell rendered moving or still images, resold as a part of a feature film, movie advertisement etc. You have a possibility to publish renders in a book, on a poster, t-shirt, magazine, cover or any other item. You have the right to use your renders in every way - charge a fee for them, modify them, to make postproduction etc.

FURNITURE II

collection

VOLUME 17

024

NAME

CGAxis Models Volume 17:
Furniture II Collection

FORMATS

- *.max (Scanline)
- *.max (MentalRay)
- *.max (VRay)
- *.c4d
- *.c4d (VRay)
- *.fbx
- *.obj

SPECIFICATION

Total size: 750MB
Materials: YES
Textures: YES

DESCRIPTION

CGAXIS models volume 17 containing 32 highly detailed models of furniture (sofas, armchairs, etc.) Great for your interiors, compatible with 3ds max 2008 or higher and many others.

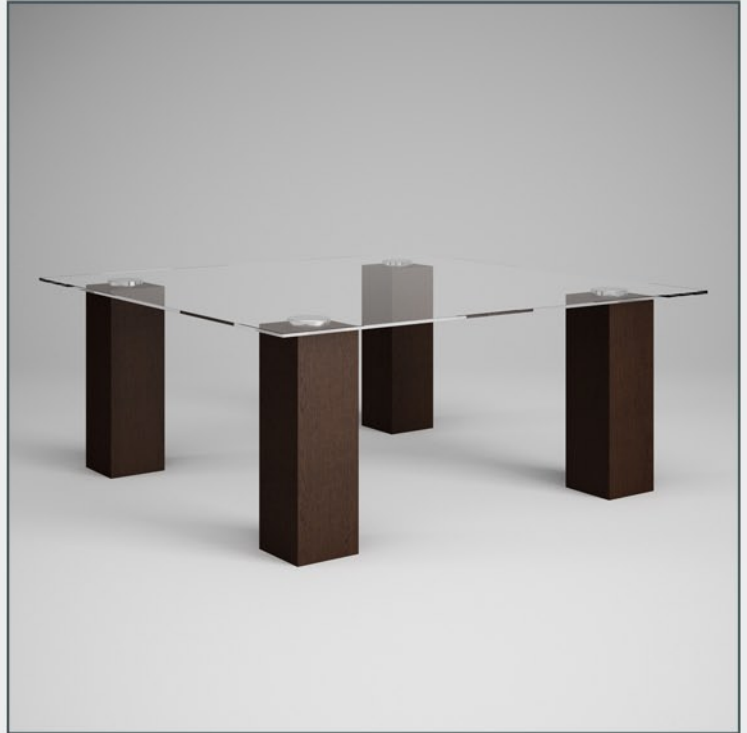

All models, textures, renders, materials, hdri etc. which can be purchased/downloaded from www.cgaxis.com are on Royalty-Free non-exclusive license. License is personal and NON transferable. Models, textures, renders, materials, hdri etc. that You have purchased are non-exclusively licensed, NOT sold to You. You can use CGAxis products as a part of a game, if the products are contained inside a propriety format and displays inside the game during play. In this case, you have to add in the producer's section the information that "models by CGAXIS.com". You can sell/resell rendered moving or still images, resold as a part of a feature film, movie advertisement etc. You have a possibility to publish renders in a book, on a poster, t-shirt, magazine, cover or any other item. You have the right to use your renders in every way - charge a fee for them, modify them, to make postproduction etc.

FURNITURE II

collection

VOLUME 17

025

NAME

CGAxis Models Volume 17:
Furniture II Collection

FORMATS

- *.max (Scanline)
- *.max (MentalRay)
- *.max (VRay)
- *.c4d
- *.c4d (VRay)
- *.fbx
- *.obj

SPECIFICATION

Total size: 750MB
Materials: YES
Textures: YES

DESCRIPTION

CGAXIS models volume 17 containing 32 highly detailed models of furniture (sofas, armchairs, etc.) Great for your interiors, compatible with 3ds max 2008 or higher and many others.

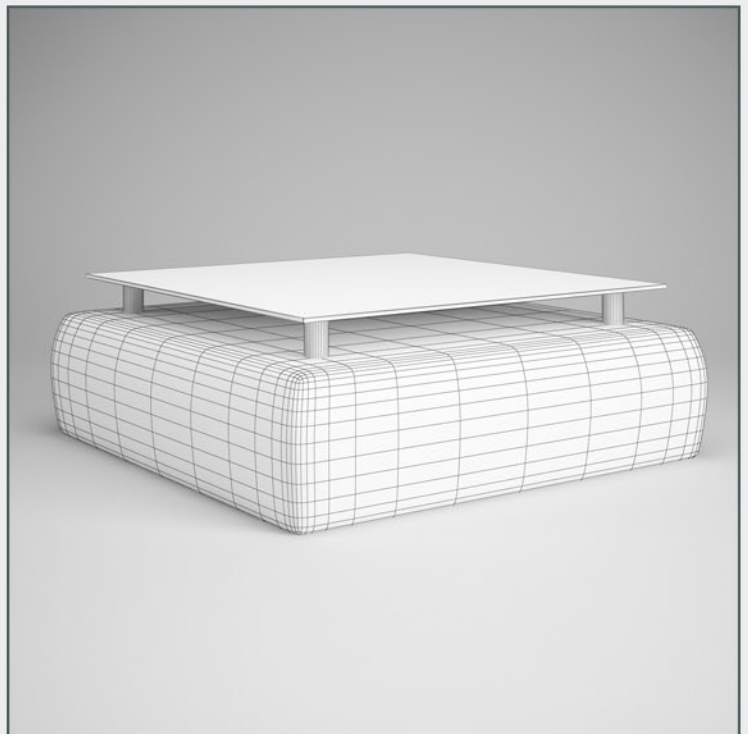
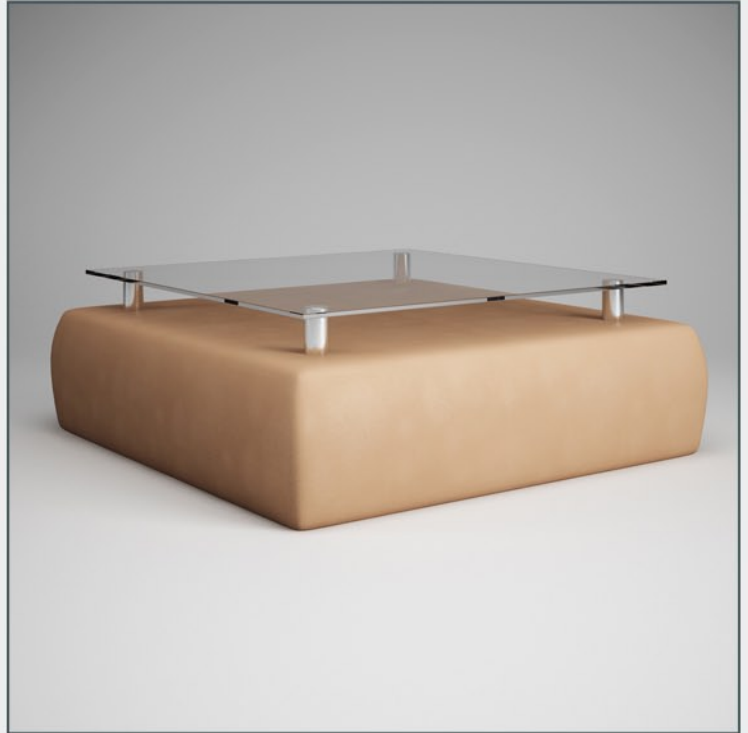

All models, textures, renders, materials, hdri etc. which can be purchased/downloaded from www.cgaxis.com are on Royalty-Free non-exclusive license. License is personal and NON transferable. Models, textures, renders, materials, hdri etc. that You have purchased are non-exclusively licensed, NOT sold to You. You can use CGAxis products as a part of a game, if the products are contained inside a propriety format and displays inside the game during play. In this case, you have to add in the producer's section the information that "models by CGAXIS.com". You can sell/resell rendered moving or still images, resold as a part of a feature film, movie advertisement etc. You have a possibility to publish renders in a book, on a poster, t-shirt, magazine, cover or any other item. You have the right to use your renders in every way - charge a fee for them, modify them, to make postproduction etc.

FURNITURE II

collection

VOLUME 17

026

NAME

CGAxis Models Volume 17:
Furniture II Collection

FORMATS

- *.max (Scanline)
- *.max (MentalRay)
- *.max (VRay)
- *.c4d
- *.c4d (VRay)
- *.fbx
- *.obj

SPECIFICATION

Total size: 750MB
Materials: YES
Textures: YES

DESCRIPTION

CGAXIS models volume 17 containing 32 highly detailed models of furniture (sofas, armchairs, etc.) Great for your interiors, compatible with 3ds max 2008 or higher and many others.



All models, textures, renders, materials, hdri etc. which can be purchased/downloaded from www.cgaxis.com are on Royalty-Free non-exclusive license. License is personal and NON transferable. Models, textures, renders, materials, hdri etc. that You have purchased are non-exclusively licensed, NOT sold to You. You can use CGAxis products as a part of a game, if the products are contained inside a propriety format and displays inside the game during play. In this case, you have to add in the producer's section the information that "models by CGAXIS.com". You can sell/resell rendered moving or still images, resold as a part of a feature film, movie advertisement etc. You have a possibility to publish renders in a book, on a poster, t-shirt, magazine, cover or any other item. You have the right to use your renders in every way - charge a fee for them, modify them, to make postproduction etc.

FURNITURE II

collection

VOLUME 17

027

NAME

CGAxis Models Volume 17:
Furniture II Collection

FORMATS

- *.max (Scanline)
- *.max (MentalRay)
- *.max (VRay)
- *.c4d
- *.c4d (VRay)
- *.fbx
- *.obj

SPECIFICATION

Total size: 750MB
Materials: YES
Textures: YES

DESCRIPTION

CGAXIS models volume 17 containing 32 highly detailed models of furniture (sofas, armchairs, etc.) Great for your interiors, compatible with 3ds max 2008 or higher and many others.



All models, textures, renders, materials, hdri etc. which can be purchased/downloaded from www.cgaxis.com are on Royalty-Free non-exclusive license. License is personal and NON transferable. Models, textures, renders, materials, hdri etc. that You have purchased are non-exclusively licensed, NOT sold to You. You can use CGAxis products as a part of a game, if the products are contained inside a propriety format and displays inside the game during play. In this case, you have to add in the producer's section the information that "models by CGAXIS.com". You can sell/resell rendered moving or still images, resold as a part of a feature film, movie advertisement etc. You have a possibility to publish renders in a book, on a poster, t-shirt, magazine, cover or any other item. You have the right to use your renders in every way - charge a fee for them, modify them, to make postproduction etc.

FURNITURE II

collection

VOLUME 17

028

NAME

CGAxis Models Volume 17:
Furniture II Collection

FORMATS

- *.max (Scanline)
- *.max (MentalRay)
- *.max (VRay)
- *.c4d
- *.c4d (VRay)
- *.fbx
- *.obj

SPECIFICATION

Total size: 750MB
Materials: YES
Textures: YES

DESCRIPTION

CGAXIS models volume 17 containing 32 highly detailed models of furniture (sofas, armchairs, etc.) Great for your interiors, compatible with 3ds max 2008 or higher and many others.

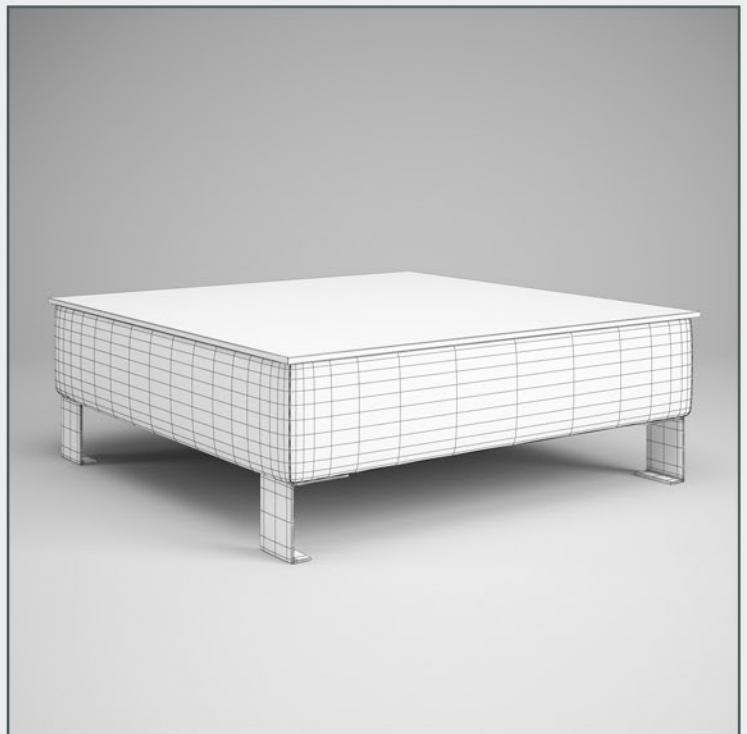

All models, textures, renders, materials, hdri etc. which can be purchased/downloaded from www.cgaxis.com are on Royalty-Free non-exclusive license. License is personal and NON transferable. Models, textures, renders, materials, hdri etc. that You have purchased are non-exclusively licensed, NOT sold to You. You can use CGAxis products as a part of a game, if the products are contained inside a propriety format and displays inside the game during play. In this case, you have to add in the producer's section the information that "models by CGAXIS.com". You can sell/resell rendered moving or still images, resold as a part of a feature film, movie advertisement etc. You have a possibility to publish renders in a book, on a poster, t-shirt, magazine, cover or any other item. You have the right to use your renders in every way - charge a fee for them, modify them, to make postproduction etc.

FURNITURE II

collection

VOLUME 17

029

NAME

CGAxis Models Volume 17:
Furniture II Collection

FORMATS

- *.max (Scanline)
- *.max (MentalRay)
- *.max (VRay)
- *.c4d
- *.c4d (VRay)
- *.fbx
- *.obj

SPECIFICATION

Total size: 750MB
Materials: YES
Textures: YES

DESCRIPTION

CGAXIS models volume 17 containing 32 highly detailed models of furniture (sofas, armchairs, etc.) Great for your interiors, compatible with 3ds max 2008 or higher and many others.



All models, textures, renders, materials, hdri etc. which can be purchased/downloaded from www.cgaxis.com are on Royalty-Free non-exclusive license. License is personal and NON transferable. Models, textures, renders, materials, hdri etc. that You have purchased are non-exclusively licensed, NOT sold to You. You can use CGAxis products as a part of a game, if the products are contained inside a propriety format and displays inside the game during play. In this case, you have to add in the producer's section the information that "models by CGAXIS.com". You can sell/resell rendered moving or still images, resold as a part of a feature film, movie advertisement etc. You have a possibility to publish renders in a book, on a poster, t-shirt, magazine, cover or any other item. You have the right to use your renders in every way - charge a fee for them, modify them, to make postproduction etc.

FURNITURE II

collection

VOLUME 17

030

NAME

CGAxis Models Volume 17:
Furniture II Collection

FORMATS

- *.max (Scanline)
- *.max (MentalRay)
- *.max (VRay)
- *.c4d
- *.c4d (VRay)
- *.fbx
- *.obj

SPECIFICATION

Total size: 750MB
Materials: YES
Textures: YES

DESCRIPTION

CGAXIS models volume 17 containing 32 highly detailed models of furniture (sofas, armchairs, etc.) Great for your interiors, compatible with 3ds max 2008 or higher and many others.

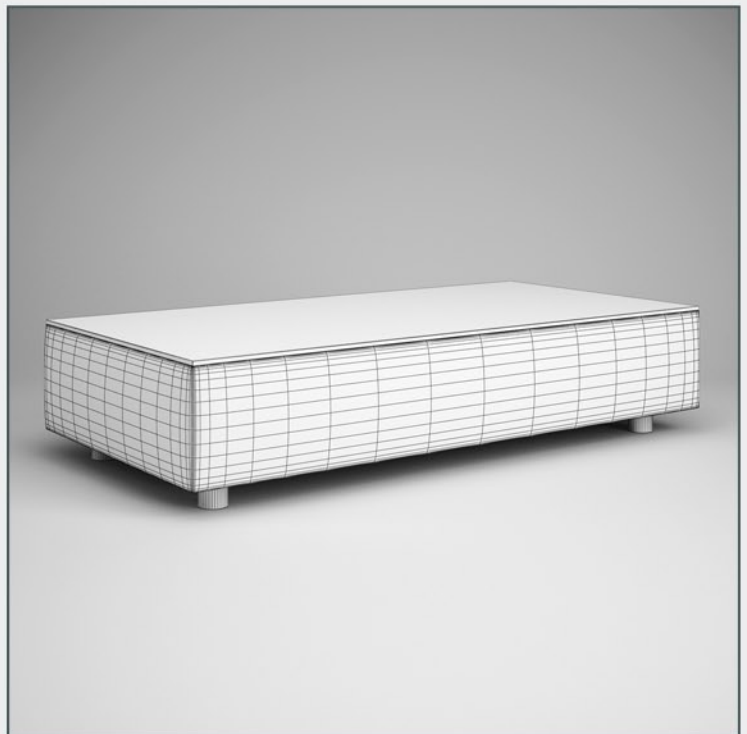

All models, textures, renders, materials, hdri etc. which can be purchased/downloaded from www.cgaxis.com are on Royalty-Free non-exclusive license. License is personal and NON transferable. Models, textures, renders, materials, hdri etc. that You have purchased are non-exclusively licensed, NOT sold to You. You can use CGAxis products as a part of a game, if the products are contained inside a propriety format and displays inside the game during play. In this case, you have to add in the producer's section the information that "models by CGAXIS.com". You can sell/resell rendered moving or still images, resold as a part of a feature film, movie advertisement etc. You have a possibility to publish renders in a book, on a poster, t-shirt, magazine, cover or any other item. You have the right to use your renders in every way - charge a fee for them, modify them, to make postproduction etc.

FURNITURE II

collection

VOLUME 17

031

NAME

CGAxis Models Volume 17:
Furniture II Collection

FORMATS

- *.max (Scanline)
- *.max (MentalRay)
- *.max (VRay)
- *.c4d
- *.c4d (VRay)
- *.fbx
- *.obj

SPECIFICATION

Total size: 750MB
Materials: YES
Textures: YES

DESCRIPTION

CGAXIS models volume 17 containing 32 highly detailed models of furniture (sofas, armchairs, etc.) Great for your interiors, compatible with 3ds max 2008 or higher and many others.



All models, textures, renders, materials, hdri etc. which can be purchased/downloaded from www.cgaxis.com are on Royalty-Free non-exclusive license. License is personal and NON transferable. Models, textures, renders, materials, hdri etc. that You have purchased are non-exclusively licensed, NOT sold to You. You can use CGAxis products as a part of a game, if the products are contained inside a propriety format and displays inside the game during play. In this case, you have to add in the producer's section the information that "models by CGAXIS.com". You can sell/resell rendered moving or still images, resold as a part of a feature film, movie advertisement etc. You have a possibility to publish renders in a book, on a poster, t-shirt, magazine, cover or any other item. You have the right to use your renders in every way - charge a fee for them, modify them, to make postproduction etc.

FURNITURE II

collection

VOLUME 17

032

NAME

CGAxis Models Volume 17:
Furniture II Collection

FORMATS

- *.max (Scanline)
- *.max (MentalRay)
- *.max (VRay)
- *.c4d
- *.c4d (VRay)
- *.fbx
- *.obj

SPECIFICATION

Total size: 750MB
Materials: YES
Textures: YES

DESCRIPTION

CGAXIS models volume 17 containing 32 highly detailed models of furniture (sofas, armchairs, etc.) Great for your interiors, compatible with 3ds max 2008 or higher and many others.



All models, textures, renders, materials, hdri etc. which can be purchased/downloaded from www.cgaxis.com are on Royalty-Free non-exclusive license. License is personal and NON transferable. Models, textures, renders, materials, hdri etc. that You have purchased are non-exclusively licensed, NOT sold to You. You can use CGAxis products as a part of a game, if the products are contained inside a propriety format and displays inside the game during play. In this case, you have to add in the producer's section the information that "models by CGAXIS.com". You can sell/resell rendered moving or still images, resold as a part of a feature film, movie advertisement etc. You have a possibility to publish renders in a book, on a poster, t-shirt, magazine, cover or any other item. You have the right to use your renders in every way - charge a fee for them, modify them, to make postproduction etc.